



Installation Manual Double DIN Kit

Part No.: CT23FD28

Ford Focus 2011 >

Compatible with these double DIN devices

Double DIN Navigation

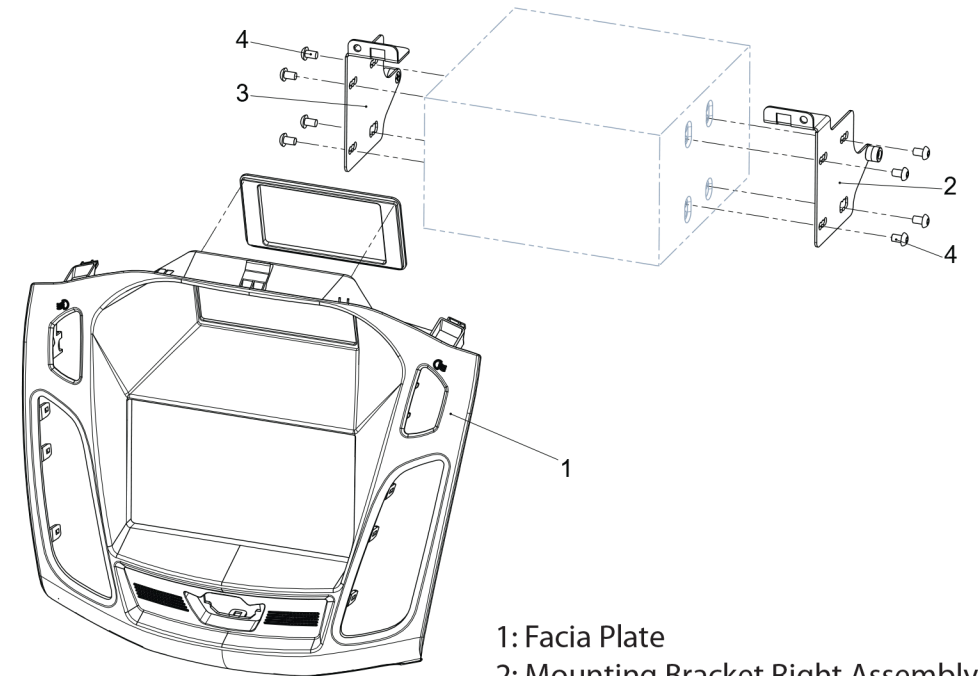

- 1: Facia Plate
- 2: Mounting Bracket Right Assembly
- 3: Mounting Bracket Left Assembly
- 4: Flat Headed Screw



Spare OEM hazard light
switch by Ford required (1690881)



1. Ford Focus OEM Dashboard (sample photo)

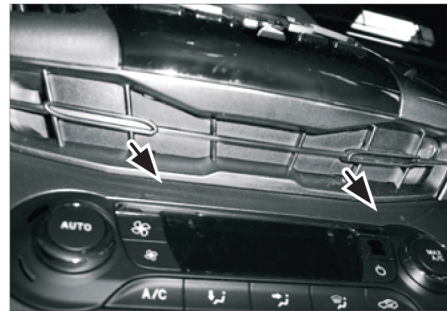

2. Unclip panel under OEM radio

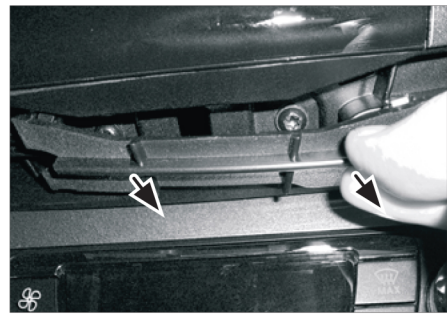

3. Remove Panel under OEM radio

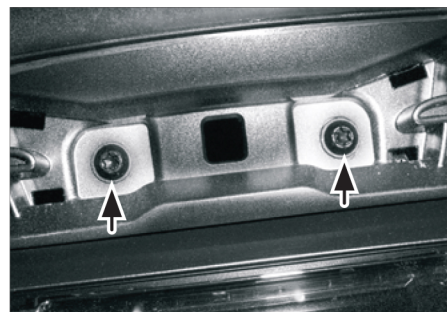

4. These 2 screws need to be removed

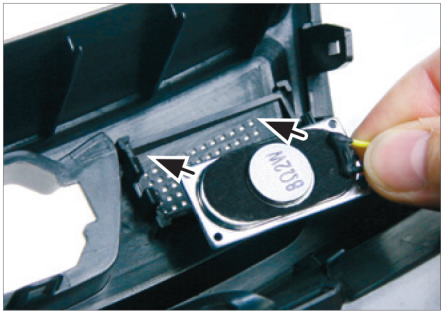

14. as needed fix speaker with cyanoacrylate adhesive



15. A spare OEM hazard light switch by Ford is required.



16. Mount spare hazard light switch to facia plate. Clip facia plate on dash board. Install everything in reverse order.

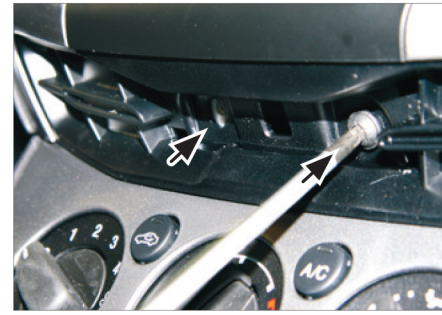

4a. Remove 2 screws under OEM radio



5. Unclip OEM panel



6. Remove OEM panel carefully

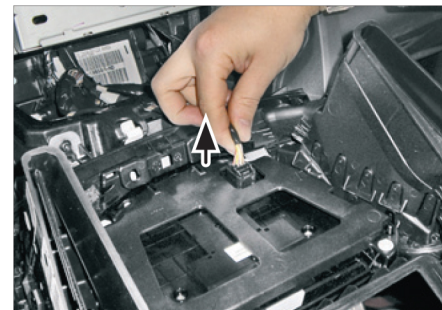

7. Unplug cables

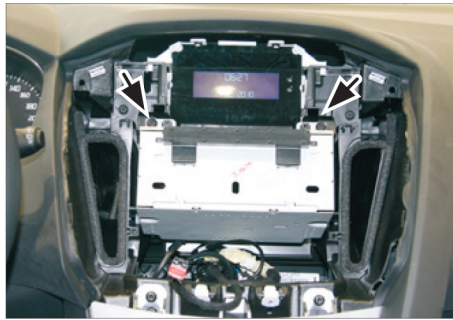

8. Remove 2 screws (see arrows)
Remove OEM head unit

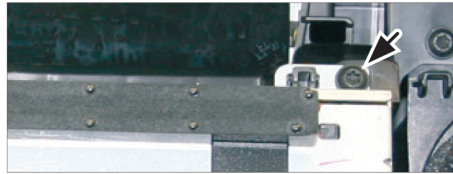

9. OEM dash board with removed head unit

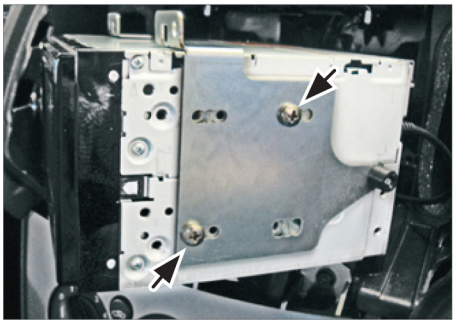

10. Mount mounting brackets to double DIN head unit



11. Install double DIN head unit
Connect all required circuit points and connections. Please see stalk interface manual for connecting stalk interface
Fix navigation with OEM screws

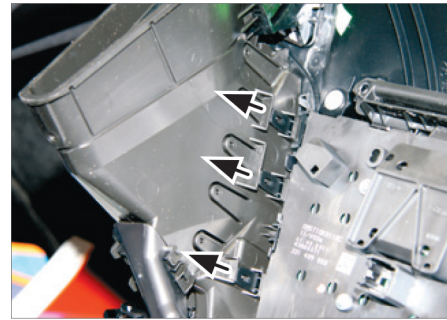

Preperation of fascia plate

12. Unclip 2 OEM air vents

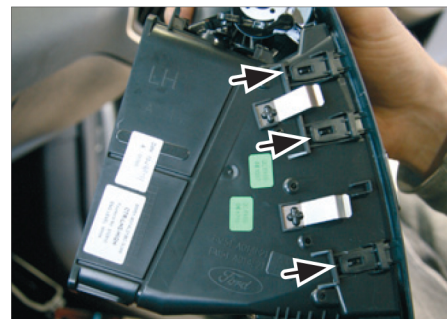

Preperation of fascia plate

13. Mount them to new fascia plate



The Focus is equipped with two kinds of OEM displays

A: Display with 2 buttons at right side (see arrow)

No trim frame required



B: Colour Display:

Clip trim frame to fascia plate

